



COYOTE® Dome Closure 6-1/2" x 17"

Be sure to read and completely understand this procedure before applying product. Be sure to select the proper PREFORMED™ product before application.



NOMENCLATURE











- | | |
|---|---|
| 1. Dome cover (1) | 5. Dome Collar (1) |
| 2. Organizer with 4-Port End Plate Assembly | 6. Silicone Lubricant (4 five gram packets) |
| 3. Transport Tubing Kit (1)
(In Dome Kits for Unitube/Ribbon Applications) | 7. Cable Grommet (2) |
| 4. Dome Gasket (1) | 8. Hose Clamp (4) |
| | 9. Strength Member Bracket (2) |
| | 10. Disposable Glove (1) |

TOOLS REQUIRED

- 3/8" & 7/16" Can wrench or socket
- 1/4" Nut driver or screwdriver
- Snips
- Fiber optic cable opening tools

6.5" x 17" COYOTE Dome Closure Kits	
Catalog Number	Description
8006944	COYOTE 6.5" x 17" Dome Closure for Buffer Tube Applications. Includes: (2) Grommets, (1) Buffer Tube Organizer Assembly with 4-Port End Plate Assembly, (1) Dome, (1) Collar Assembly, (1) Gasket, (1) Small Parts Bag
8006945	COYOTE 6.5" x 17" Dome Closure for Unitube/Ribbon Applications. Includes: (2) Grommets, (1) Transition Tray Organizer Assembly with 4-Port End Plate Assembly, (1) Dome, (1) Collar Assembly, (1) Gasket, (1) Transition Tubing Kit, (2) Transport Tubing Kits, (1) Small Parts Bag
Accessory Kits	
COYEPPFIX1	COYOTE Dome End Plate Fixture
Mounting Brackets	
8003831	Aerial Mounting Bracket (Dome Mount) - Strand Applications
8004035	Aerial Adjustable Offset Mounting Bracket (Dome Mount) - Strand Applications
8003833	Aerial Mounting Bracket (Dome Mount) - ADSS Applications
8004036	Aerial Adjustable Offset Mounting Bracket (Dome Mount) - ADSS Applications
8003702	Pole/Wall Mounting Bracket
8003835	Universal Mounting Bracket Kit for Hand Hole Applications
8003707	Swing Arm for Hand Hole Applications
8004003	Manhole Support

Splice Tray/Closure Capacities for 6.5" x 17" COYOTE® Dome Closures				
Splice Tray	Catalog #	Splice Type	Trays per Closure	Closure Splice Capacity
Low Profile LITE-GRIP® (24 ct)	80809958	Single Fusion	6	144
LITE-GRIP (40 ct)	80808945	Single Fusion	3	120
LITE-GRIP (144 ct)	LGSTR144	Mass Fusion/ Ribbon	3	432

COYOTE Grommet Chart For use in COYOTE GLC, Aerial, LCC, Dome, In-Line RUNT, Taut & Terminal Closures			
PLP Catalog Number	Cable Range Inches (mm)	Description	Splitting Location
8003691	.42 - .60 (11 - 15 mm)	1-entry grommet	
8003692	.60 - .85 (15 - 22 mm)	1-entry grommet	
8003693	.85 - 1.0 (22 - 25 mm)	1-entry grommet	
8003694	1.0 - 1.25 (25 - 32 mm)	1-entry grommet	
8003663	.42 - .60 (11 - 15 mm)	2-entry grommet	
8003664	.30 - .43 (8 - 11mm)	4-entry grommet	
8004065	.250 - .312 (6.4 - 7.9 mm)	4-entry grommet	
8003990	.50 - .60 (12.7 - 15.2 mm) .125 - .25 (3.2 - 6.4 mm) and flat drop	4-entry grommet	
8003665	.125 - .25 (3 - 6 mm)	6-entry grommet	
8003676	.42 - .60 (11 - 15 mm) .125 - .25 (3 - 6 mm)	7-entry grommet	
8003677	.125 - .25 (3 - 6 mm)	8-entry grommet	

NOTE: Grommet Kit contains (1) Grommet, (1) Cable Measure Tape, (2) Silicone Lubricant Packs, (1) Set of Plugs & (1) Glove

End Plate Preparation

Step #1 Remove support bar mounting clip from organizer assembly.

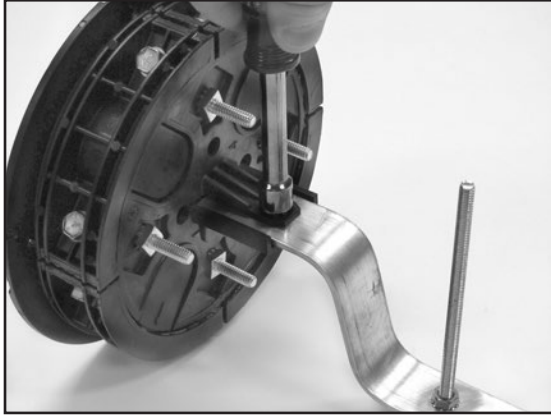

Step #2 Remove end plate from organizer assembly.

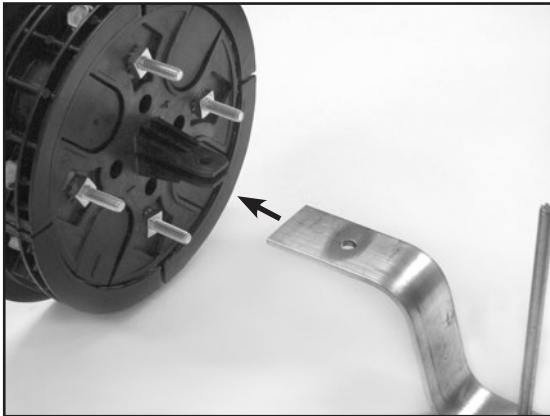

Step #3 Remove the end plate caps from the selected ports and break out the tabs.

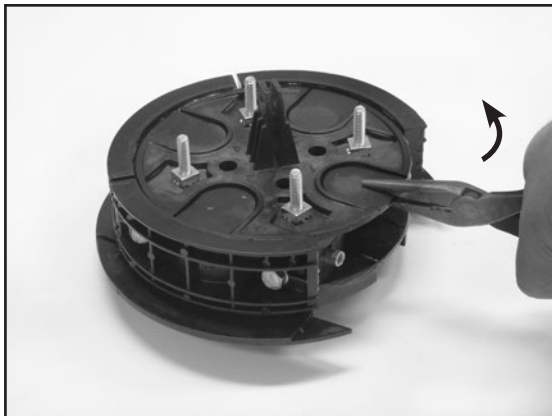

Step #4 Reassemble organizer assembly to end plate with mounting clip and 1/4" hex bolt and nut.

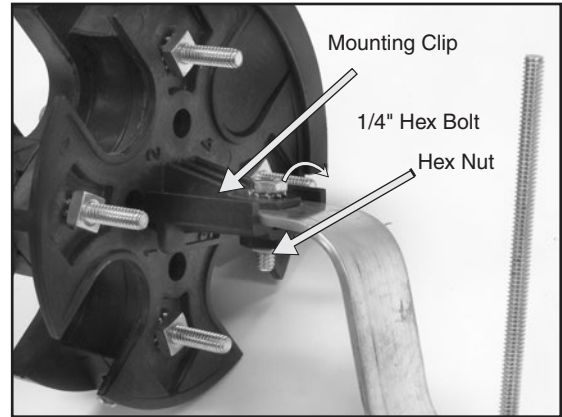

Cable Preparation

Step #5 Measure cable to determine diameter and hole location to use in grommet.



Step #6a If using cut cable, insert cable through grommet. If your application requires express/balloon/ring cut cables, see Step 7 for grommet slitting procedure.

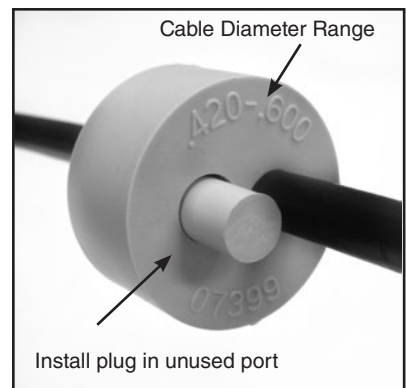

Step #6b Installing Figure 8 Style Cables and Cables with Tracer Wires - Remove tracer wire or ground wire from the portion of the cable that will be positioned in the grommet and insert cable into grommet.

Cable with Tracer Wire

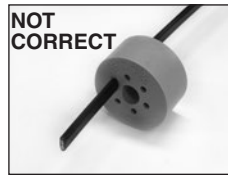

NOT CORRECT
Not Correct Installation



Correct Installation

Figure 8 Style Cable

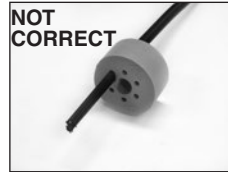

NOT CORRECT
Not Correct Installation

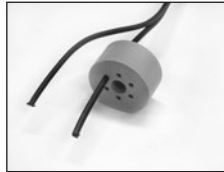

Correct Installation

Step #7 Grommet Slitting – If slitting is required, lay grommet on a stable flat surface. Position utility knife with the cutting edge against the top surface and cut through grommet. **Consult grommet chart on page 2 for slitting locations of all grommets.**

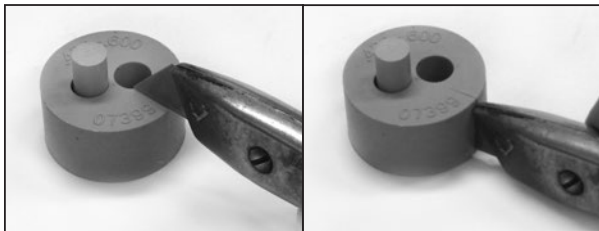

PLP Tip: Use a pen to sketch slitting lines on top surface of grommet prior to cutting.

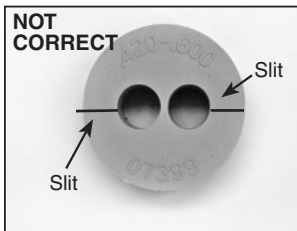

NOT CORRECT
Not Correct Slitting Angle

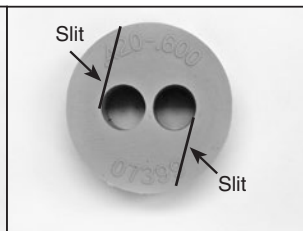

Correct Slitting Angle

Step #8 Prepare loose tube/buffer tube or unitube/ribbon cable(s) for cut applications.

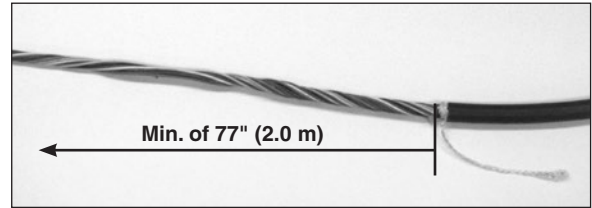

Minimum Sheath Opening for Cut Cable Applications	
Min. of 77"	2.0 m

PLP Tip: Leave about 8" (203 mm) of strength member to trim later.

Step #9a Prepare loose tube/buffer tube or unitube/ribbon cable(s) for mid sheath applications (Express/Balloon/Ring Cut).

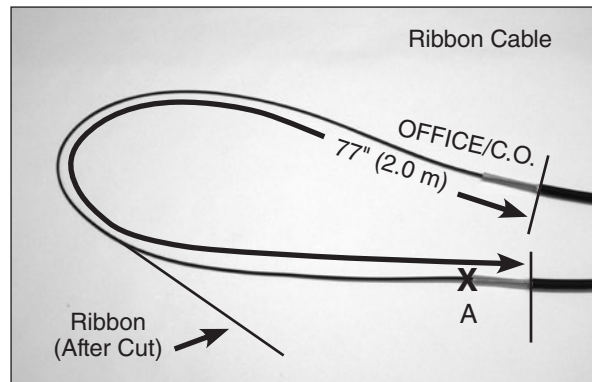
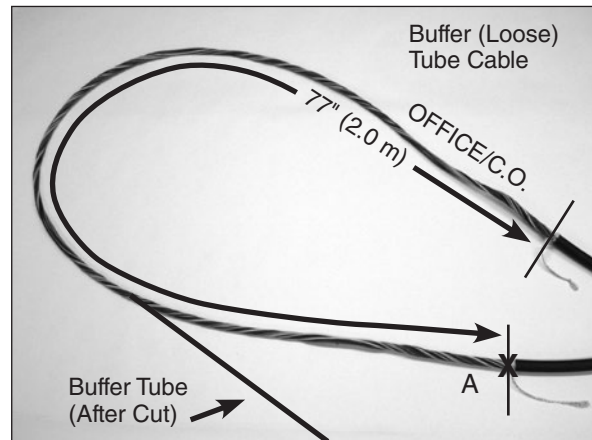

NOTE: When expressing ribbons in the transition tray of the closure at this measurement, the maximum number of ribbons that can be expressed is 24 ribbons (288 fibers).

For Applications Where Fiber is Dedicated to the Splice Point	
Sheath Opening	Min. of 77" (2.0 m)
Fiber/Buffer Tube Cut Location	A (see image above)

PLP Tip: Leave about 8" (203 mm) of strength member to trim later.

Step #9b Prepare loose tube/buffer tube or unitube/ribbon cable(s) for mid sheath applications (Express/Balloon/Ring Cut).

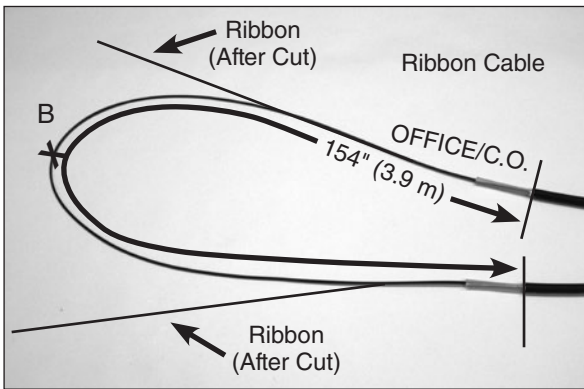
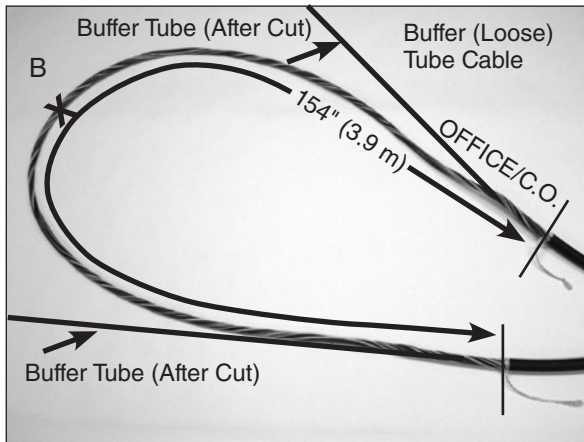

NOTE: When expressing ribbons in the transition tray of the closure at this measurement, the maximum number of ribbons that can be expressed is 12 ribbons (144 fibers).

For Applications Where Fiber is NOT Dedicated to the Splice Point	
Sheath Opening	Max. of 154" (3.9 m)
Fiber/Buffer Tube Cut Location	B (see image above)

PLP Tip: Leave about 8" (203 mm) of strength member to trim later.

Cable Sheath Opening for Applications Where Fiber is Expressed through the Buffer Tube

Step #9c Prepare loose tube/buffer tube cable(s) for expressed fiber (buffer tube window cut).

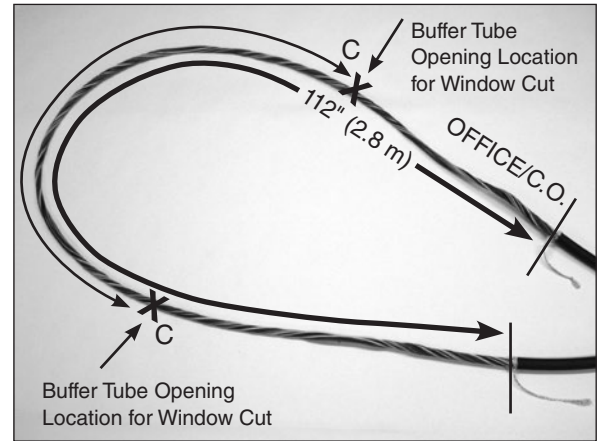

For Applications Where Fiber is Expressed through the Buffer Tube

Sheath Opening	112" (2.8 m)
Buffer Tube Opening Location	C (see image above)

PLP Tip: Leave about 8" (203 mm) of strength member to trim later.

Step #10 Prepare Central/Buffer Tube(s) for Unitube/Ribbon Cable Applications.

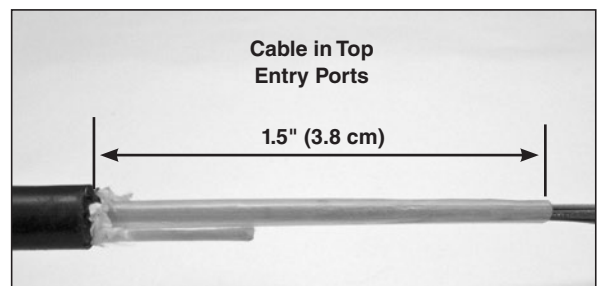
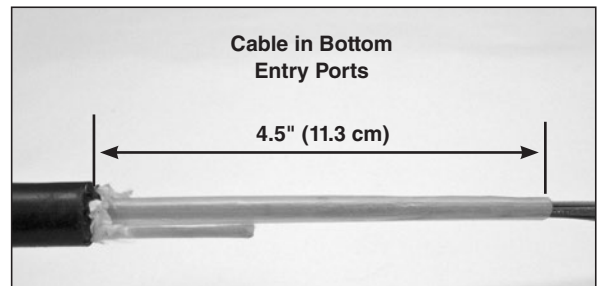

Step #11 If the cable contains Kevlar®, braid roughly 3" (7.2 cm) of the Kevlar.

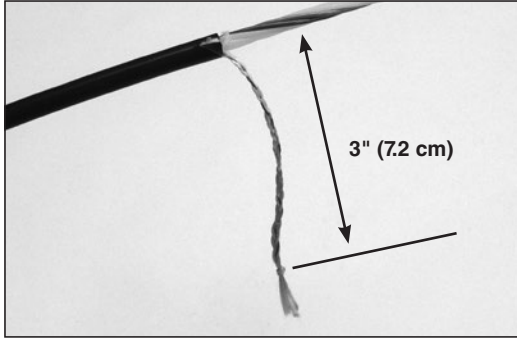

Step #12 Align sheath opening with end of slot of the strength member bracket as shown.

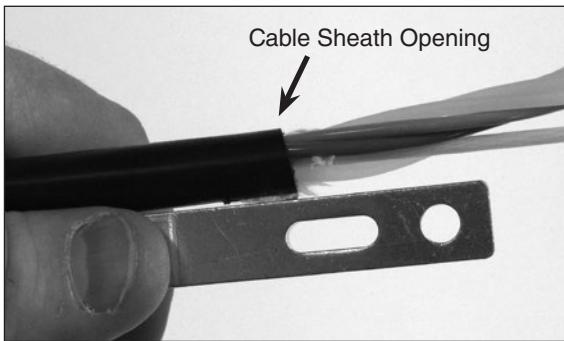

Step #13 Trim strength member(s) flush with end of the strength member bracket(s).

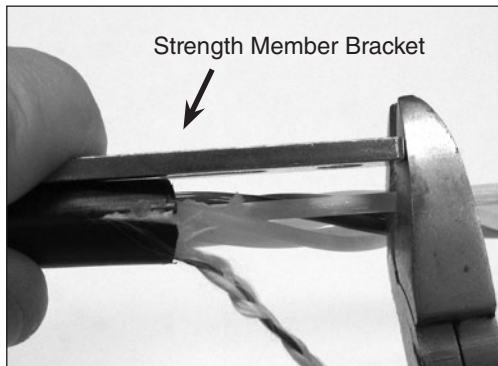

Step #14 Install cap on strength member bracket.

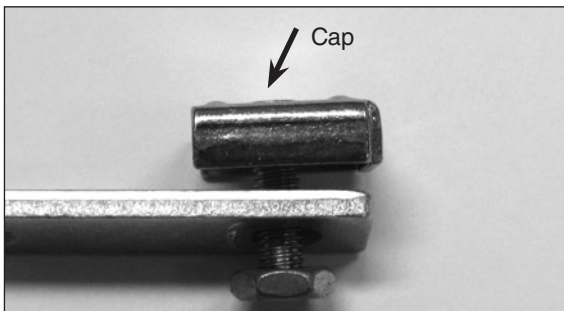

Step #15 Position strength member under cap of strength member bracket.

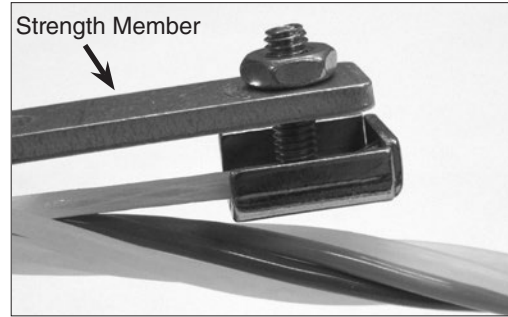

Step #16 If the cable contains Kevlar®, wrap the braided Kevlar around the stud of the cap as shown.

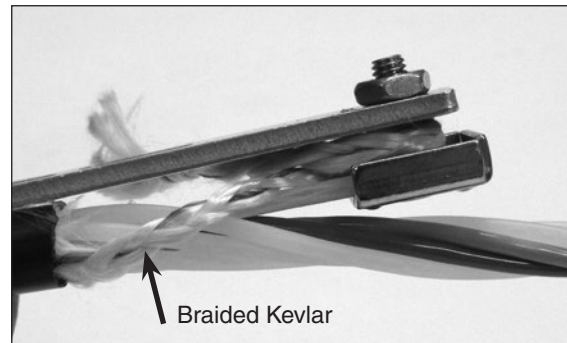

Step #17 Tighten nut of cap to secure strength member and braid under the cap.

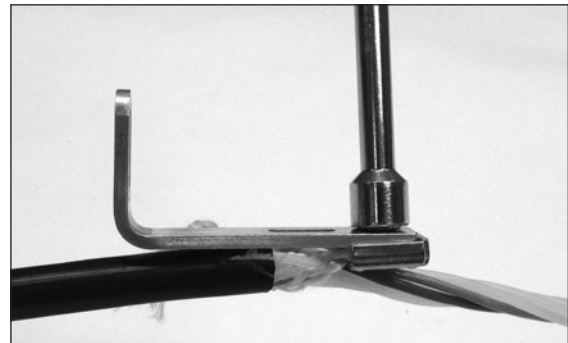

Step #18 Secure cable to strength member bracket with hose clamp.

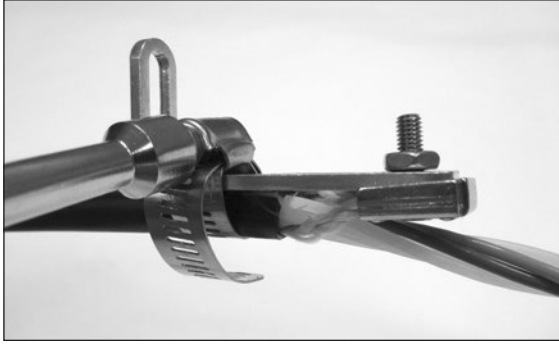

Step #21 Secure shielded cable to strength member bracket with hose clamp.

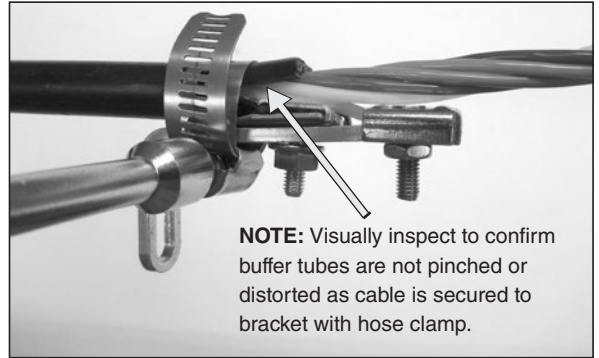

Attaching Shielded Cable to Strength Member Bracket

Step #19 For shielded cable applications, PLP recommends using a 3M 4460-D/FO Fiber Optic Shield Connector (PN: 80803989). Install shield connector on cable and insert stud of shield connector through slot of strength member bracket.

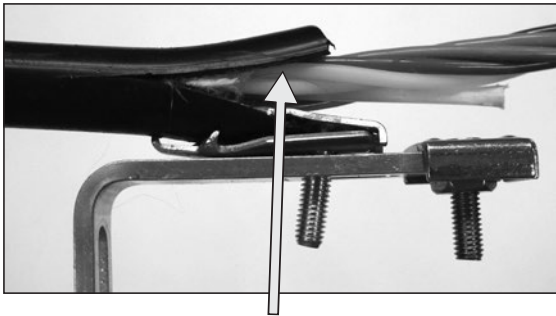

NOTE: Visually inspect to confirm buffer tubes are not pinched or distorted as shield connector is secured to bracket.

Follow standard company practices when applying shield connector to cable.

Step #20 Secure shield connector to strength member bracket with nut and secure cable strength member under cap of the strength member bracket.

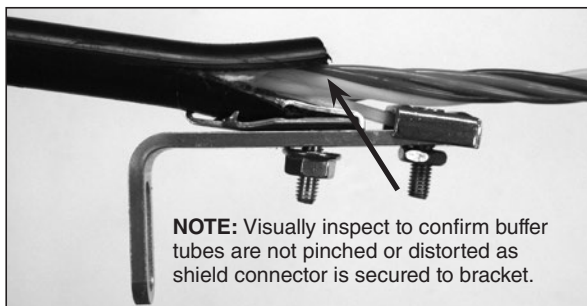

Step #22 Lubricate the outer surface of the grommet.

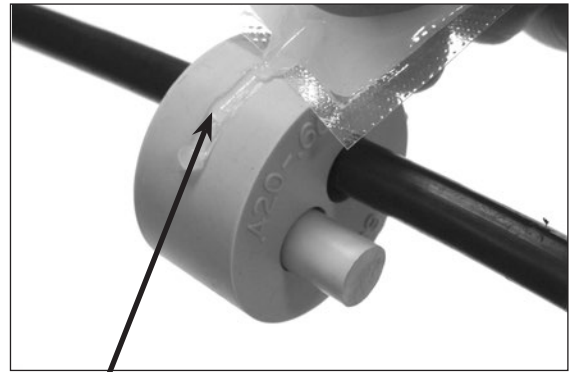

Lubricate sealing surface of grommet with silicone lubricant provided.

Step #23 Position grommets in end plate slots.

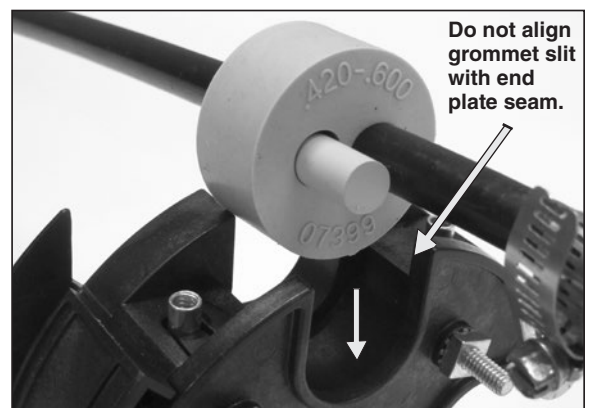

Step #24 Position slot of strength member bracket leg over stud and pull back cable.

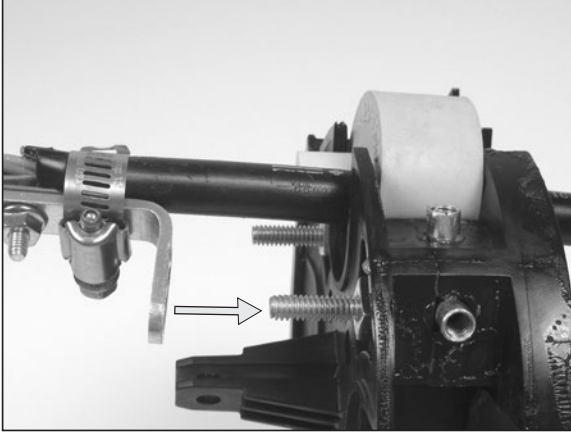

Step #25 Install strength member bracket on stud. Install lock washer and nut against the bracket, but do not tighten fully, so the bracket can slide as the grommet is inserted.

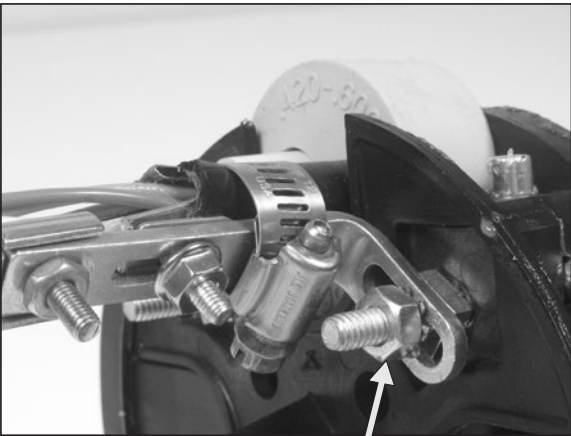

Lock Washer & Nut

Step #26 Install cable caps and secure with hex bolts.



NOTE: Tighten bolts by hand evenly until cable cap is fully seated (**DO NOT USE POWER TOOLS TO TIGHTEN BOLTS**).

When using a can wrench or nut driver, the installed torque is 35 to 40 in-lbs.

NOTE: TIGHTEN ALL UNUSED CABLE CAPS.

IMPORTANT: TIGHTEN DOWN THE STRENGTH MEMBER BRACKET AFTER THE CAPS ARE TIGHTENED.

Step #27 Complete end plate assembly.



Buffer Tube Applications

Step #28 Route and store buffer tubes in storage brackets.

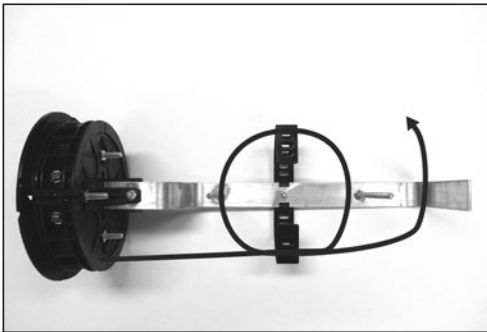
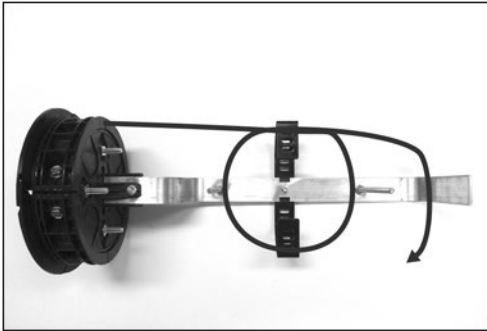

Step #29 Route buffer tube(s) to splice tray(s) and secure.

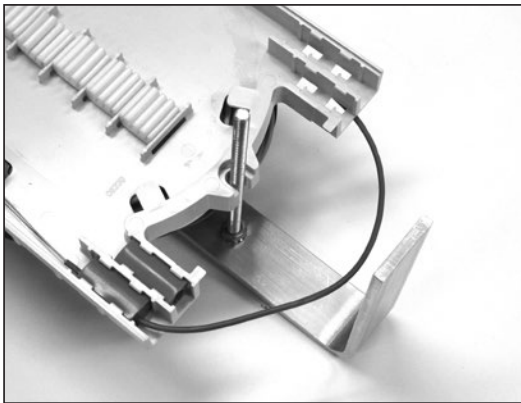

Unitube Applications

Step #30 Route and secure central tube of unitube cables to transition tray.

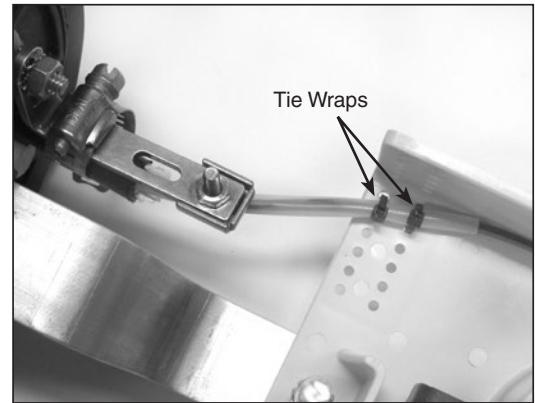

Step #31 Use transition tubes to route fibers or ribbons from upper cable ports.

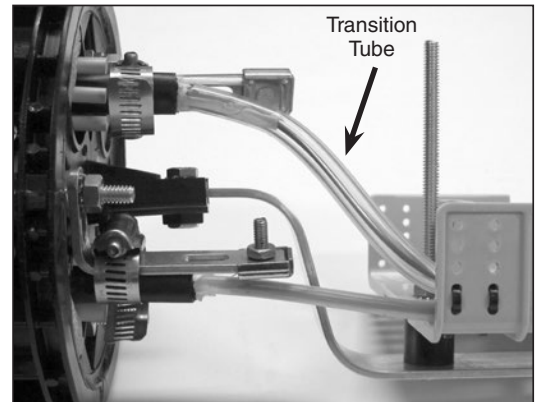

Step #32 Route feeder fibers or ribbons within transition tray.

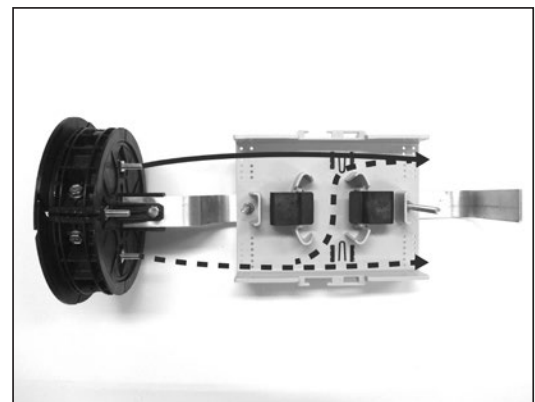

Step #33 Route express fibers or ribbons under clips.

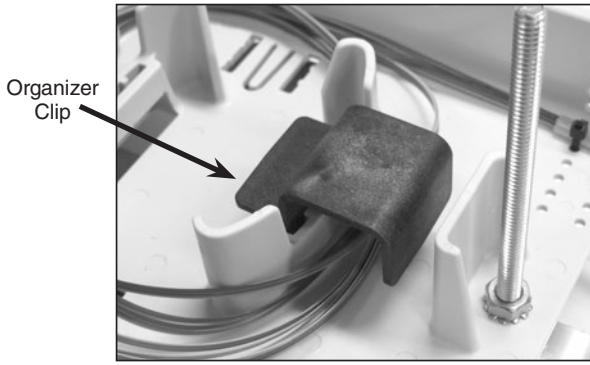

Step #34 Insert fibers or ribbons to be routed to splice tray(s) into transport tube(s) and secure tubes to transition tray.

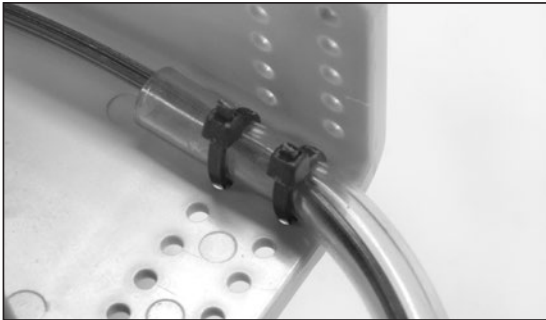

Step #35 Install cover on transition tray.

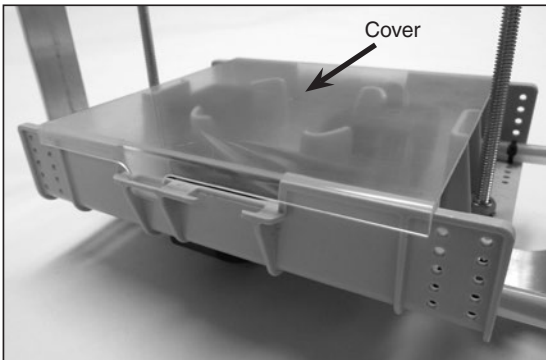

Step #36 Route transport tube(s) to splice tray(s) and secure.

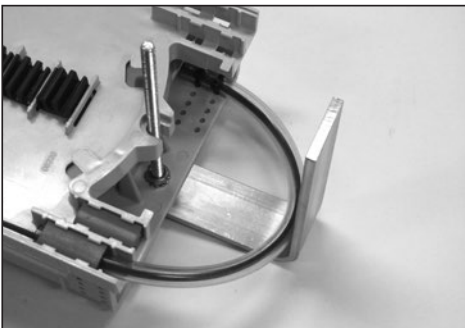

Splice Tray Management

Step #37 Route incoming fibers in splice tray.

Splices
1-12
21-32

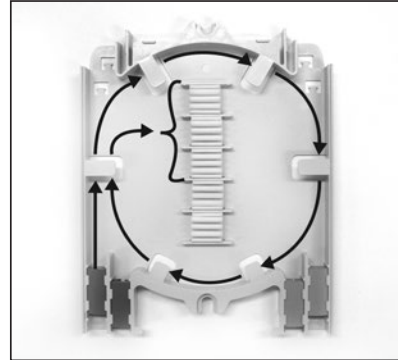

Splices
13-20
33-40

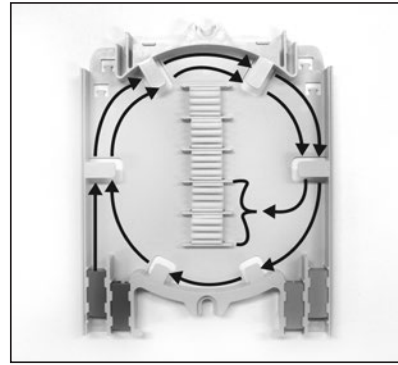

Step #38 Route outgoing fibers in splice tray.

Splices
1-12
21-32

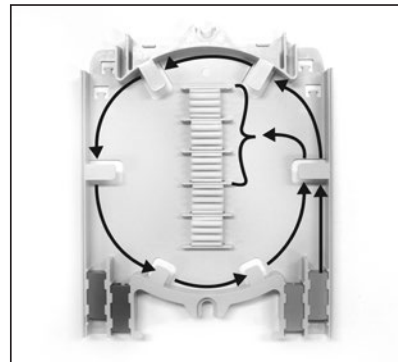

Splices
13-20
33-40

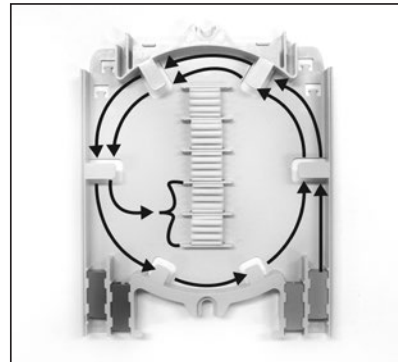

Step #39 Splice incoming fibers to outgoing pigtail fibers per your accepted company practices.

Step #40 Secure splice tray(s) with hold down strap.

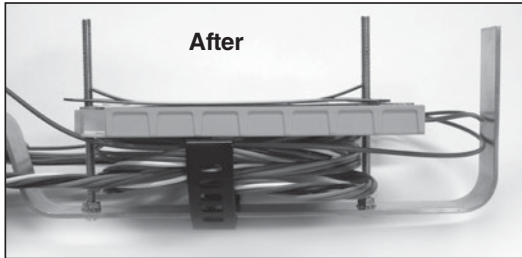
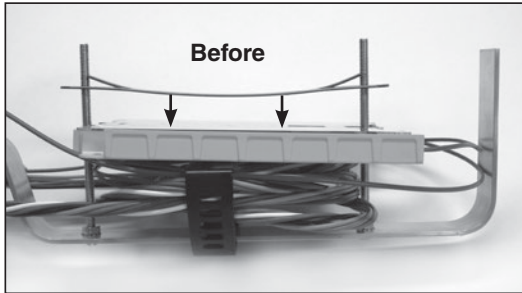

Dome & Collar Installation

Step #41 Lubricate all surfaces around gasket with silicone lubricant to assure easy assembly and closure re-entry.

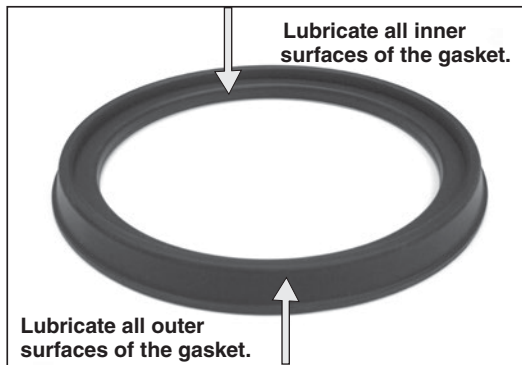

Step #42 Slide end plate gasket onto end plate and press into groove.

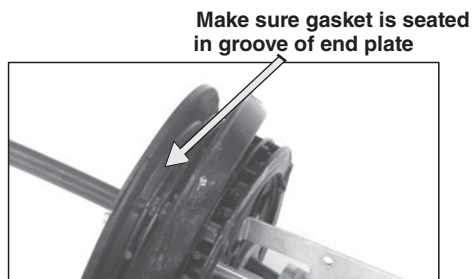

Step #43 Work the gasket into the groove.

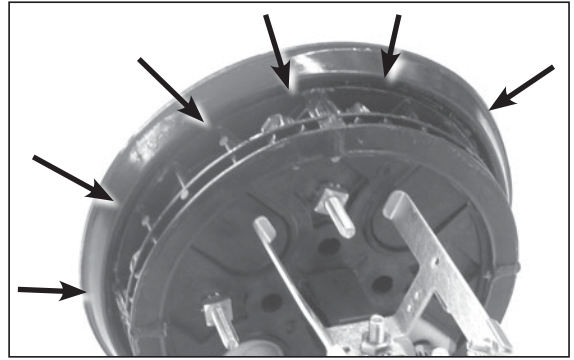

Step #44 Re-tighten all cable cap bolts (step #26) to assure that the cable caps are fully seated. When using a can wrench or nut driver, the installed torque is 35 to 40 in-lbs.

Step #45 Position the dome over end plate.

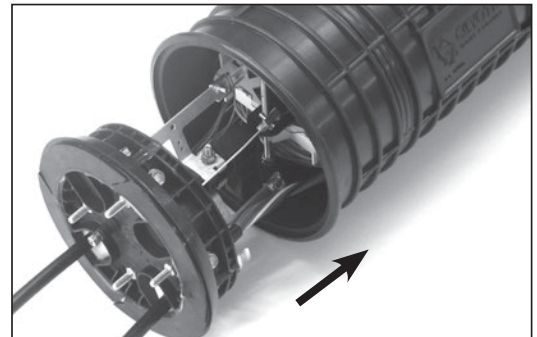

Step #46 Position the collar flat on the work surface in front of the closure as shown below.

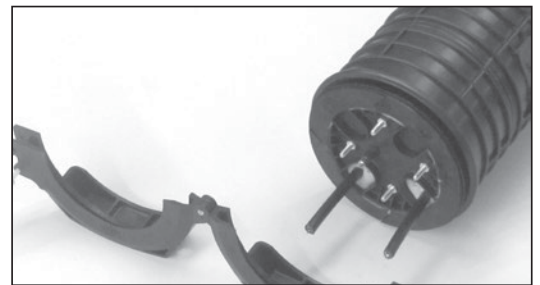

Step #47 While holding the collar in place, compress a portion of the end plate into the dome and insert them in the groove of the collar near the latch, as shown below.

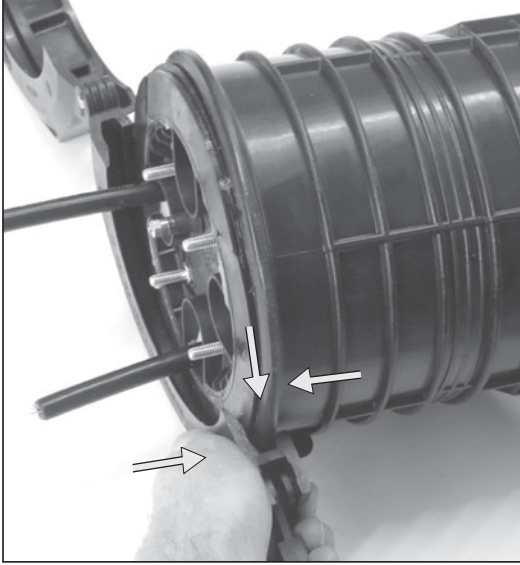

Step #49 Check to make sure the lip of the dome is captured within the collar half

Front Side

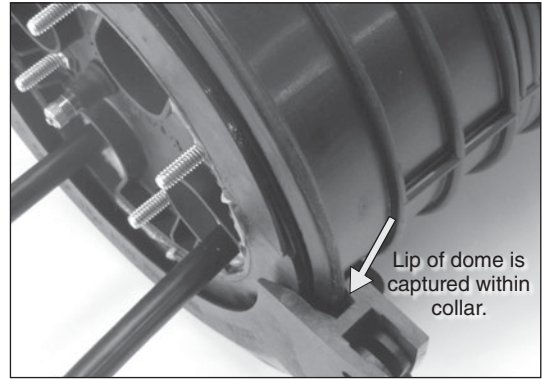

Back Side

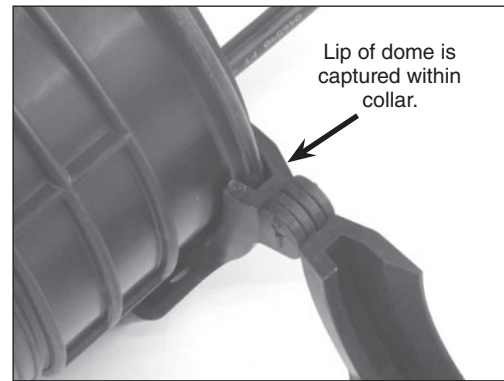

Step #48 While holding the collar in place, push against the end of the dome and slightly lift and push the other half of the dome up and over the lip of the collar with your fingers to fully install the dome in the collar half.

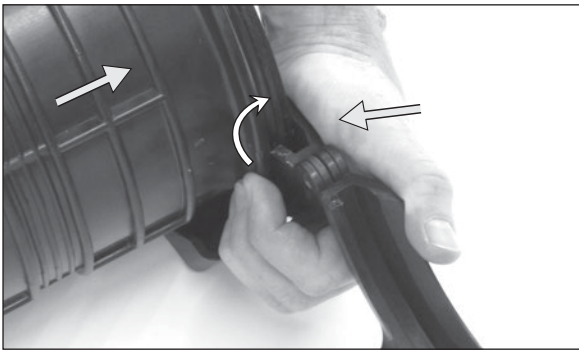

Step #50 Install the other collar half onto the closure.

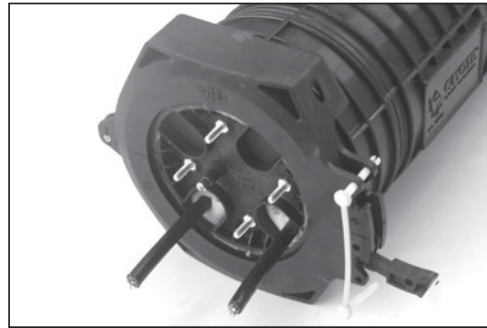

Step #51 Secure the collar with the latch and pin.



Flash Test Procedure

Step #52 Remove cap from air valve of end plate.



Step #54 Spray all sealing surfaces of the dome end-plate with soapy water to determine if there are any leaks.

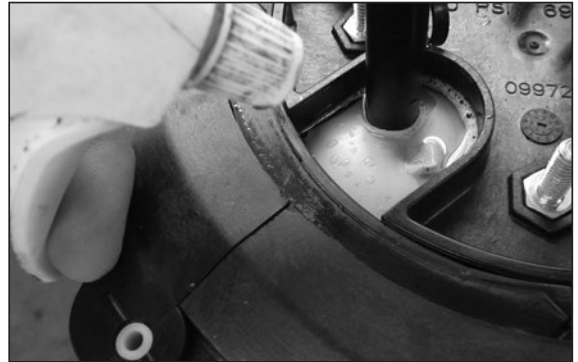

Step #53 Pressurize closure up to a max of 10 psi.



Step #55 Release the pressure in the closure using the bump on the top of the air valve cap.

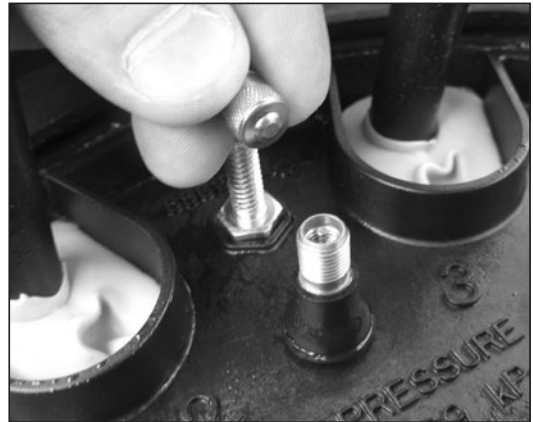

Common End Plate Leaks During Flash Testing

Leak occurring at the corner of the cable port due to the cap of the cable port not being fully tightened.



Leak occurring at the corner of the cable port

To resolve, remove collar, remove End Plate/Organizer Assembly from the Dome, and tighten bolts on end cap where leak occurred. Reassemble and flash test to confirm that the leak has stopped.

Leak occurring at the cable entry of the grommet due to the cable not being within the stated cable diameter range of the grommet



Leak occurring at the cable entry of the grommet

To resolve, remove collar and remove End Plate/Organizer Assembly from the Dome. Remove end cap where leak occurred, remove grommet, remeasure cable with measure tape provided and select proper grommet. Reassemble the components and flash test the closure to confirm that the leak has stopped.

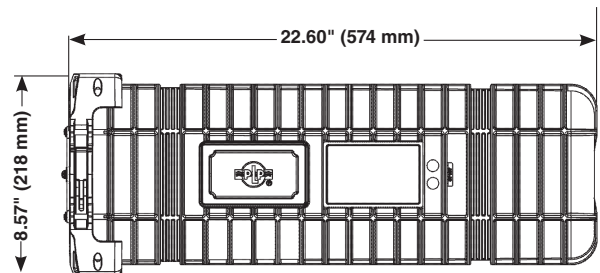
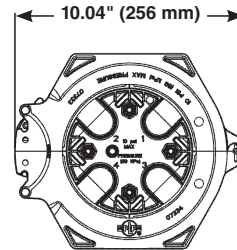
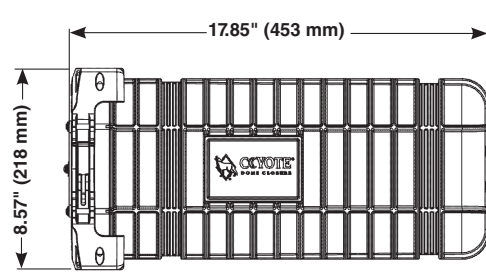

Aerial Mounting Options

Step #56a For 6.5" Dome Strand Mount Aerial Offset Bracket Kit (P/N: 8004035) and 6.5" Dome ADSS Mount Aerial Offset Bracket Kit (P/N: 8004036).

Assemble each bug nut or ADSS clamp to each top aerial offset bracket as shown below.

Strand Clamp

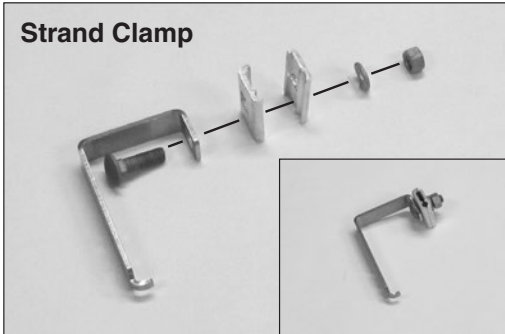

ADSS Clamp

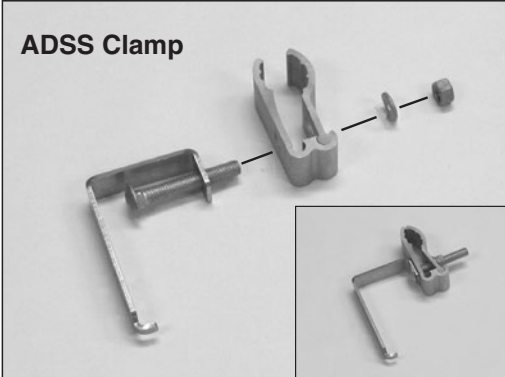

Step #56b For 6.5" Dome Strand Mount Aerial Offset Bracket Kit (P/N: 8004035) and 6.5" Dome ADSS Mount Aerial Offset Bracket Kit (P/N: 8004036).

For Shorter Spacing. Align the top aerial offset bracket with the bottom aerial offset bracket in either Position 1 or Position 2 as shown below. Secure the top aerial offset bracket to the bottom aerial offset bracket with the bolts and keps nuts provided.

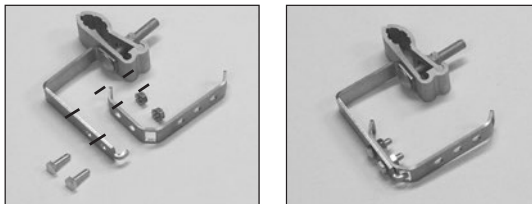

Position 1 – ADSS Clamp Shown

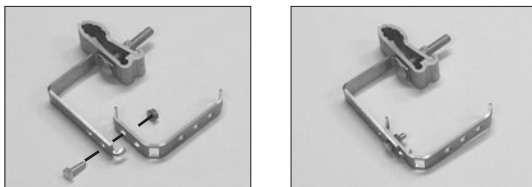

Position 2 – ADSS Clamp Shown

Step #56c For 6.5" Dome Strand Mount Aerial Offset Bracket Kit (P/N: 8004035) and 6.5" Dome ADSS Mount Aerial Offset Bracket Kit (P/N: 8004036).

For Taller Spacing. Align the top aerial offset bracket with the bottom aerial offset bracket in either Position 1 or Position 2 as shown below. Secure the top aerial offset bracket to the bottom aerial offset bracket with the bolts and keps nuts provided.



Position 1 – Strand Clamp Shown



Position 2 – Strand Clamp Shown

Step #57 6.5" Dome Strand Mount Aerial Offset Bracket Kit (P/N: 8004035) and 6.5" Dome ADSS Mount Aerial Offset Bracket Kit (P/N: 8004036). Insert hose clamp through slots in each of the bottom aerial offset brackets.

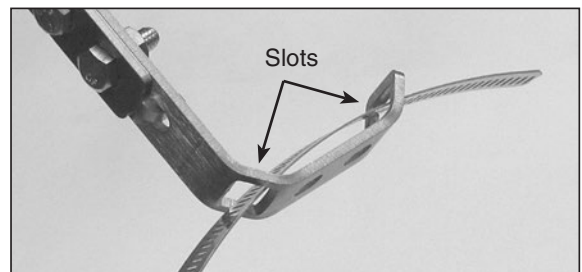

Step #58 6.5" Dome Strand Mount Aerial Offset Bracket Kit (P/N: 8004035) and 6.5" Dome ADSS Mount Aerial Offset Bracket Kit (P/N: 8004036). Tighten each hose clamp around the dome.



Step #59 6.5" Dome Strand Mount Aerial Offset Bracket Kit (P/N: 8004035) and 6.5" Dome ADSS Mount Aerial Offset Bracket Kit (P/N: 8004036).
Bracket installed on dome closure.

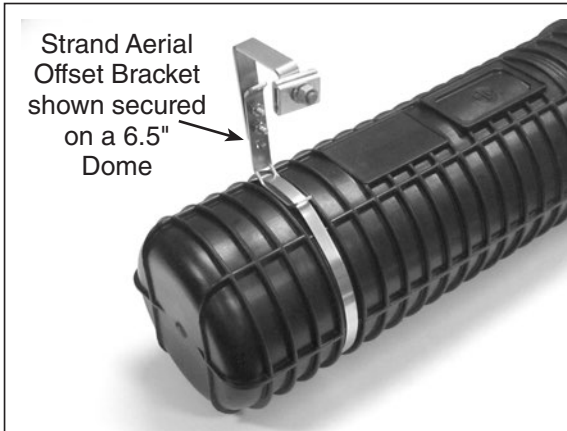

Step #62 COYOTE Universal Mounting Bracket for Hand Hole Applications (P/N: 8003835).

Position the brackets in the banding channels of the dome. Tighten the banding until the brackets are secure.

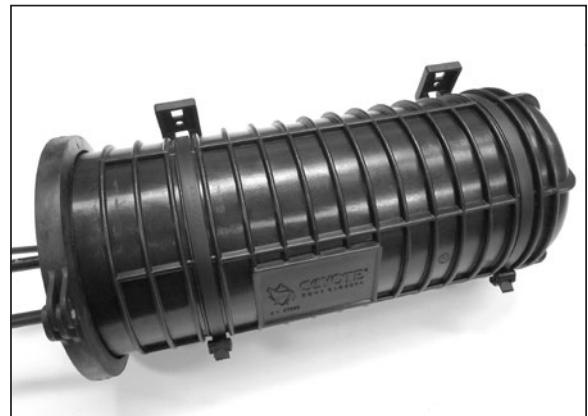

Hand Hole Mounting Option

Step #60 COYOTE Universal Mounting Bracket for Hand Hole Applications (P/N: 8003835).
Secure the Universal Mounting Bracket to the inner wall of the hand hole using 2 screws.



Step #61 COYOTE Universal Mounting Bracket for Hand Hole Applications (P/N: 8003835).

Insert banding (plastic or metal) through the slots of the hanger brackets.

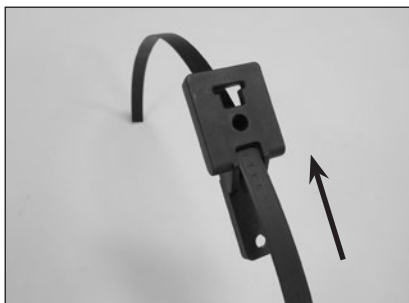

Step #63 COYOTE Universal Mounting Bracket for Hand Hole Applications (P/N: 8003835).

Slide the hanger brackets into the proper slots of the Universal Mounting Bracket and snap the hinged lid into place to secure the hanger brackets.

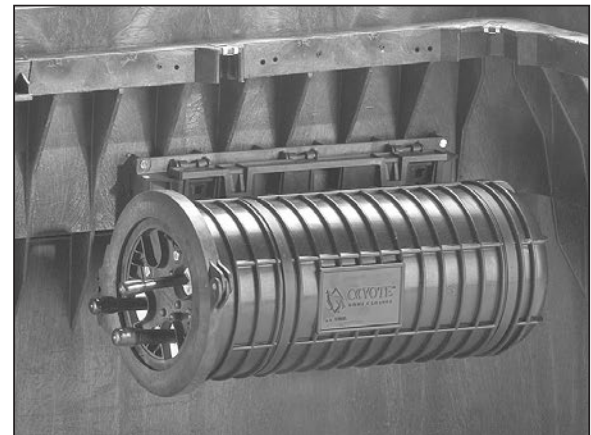

Pole/Wall Mounting Option

Step #64 The 6.5" COYOTE Dome Pole/Wall Mount Bracket (P/N: 8003702).

Position the bolts through the stud mount plate as shown, and install lock nuts on bolts until there is a 1/8" (3 mm) gap between the nut and the stud mount plate.

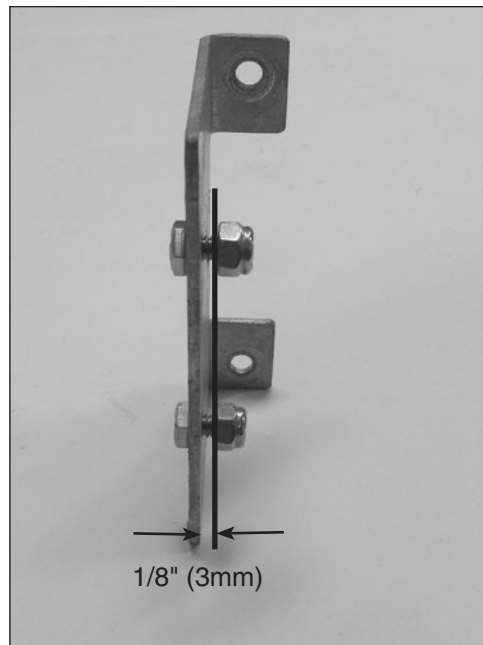
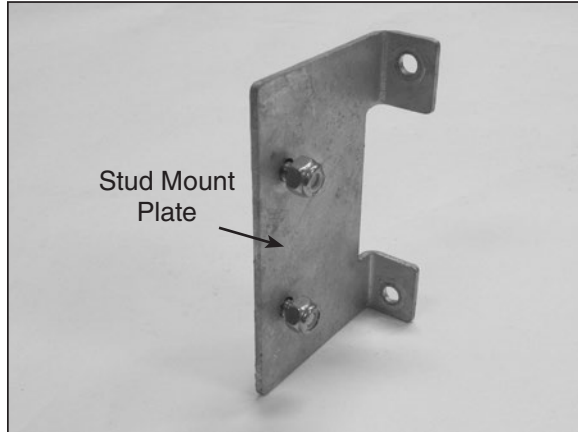

Step #65 The 6.5" COYOTE Dome Pole/Wall Mount Bracket (P/N: 8003702).

Slide the bolts of stud mount plate into the slots of the pole/wall mount bracket as shown and tighten the lock nuts until the plates are secure.

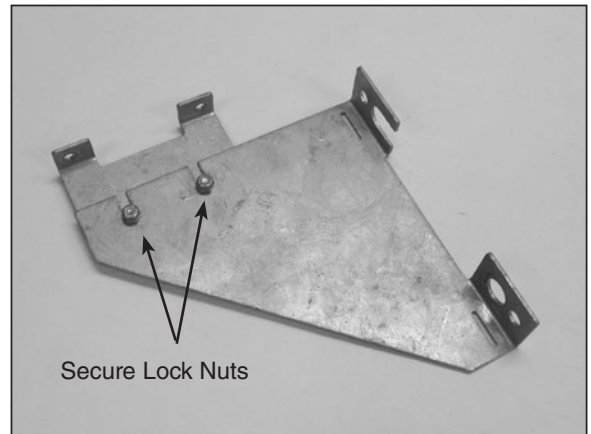
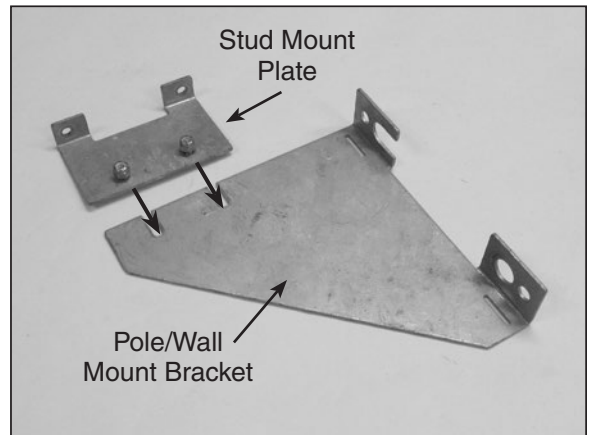

Step #65 The 6.5" COYOTE Dome Pole/Wall Mount Bracket (P/N: 8003702).

Attach the dome pole/wall mount bracket to a pole or wall with either 5/8" through bolts, 1/4" lag screws, or banding straps.

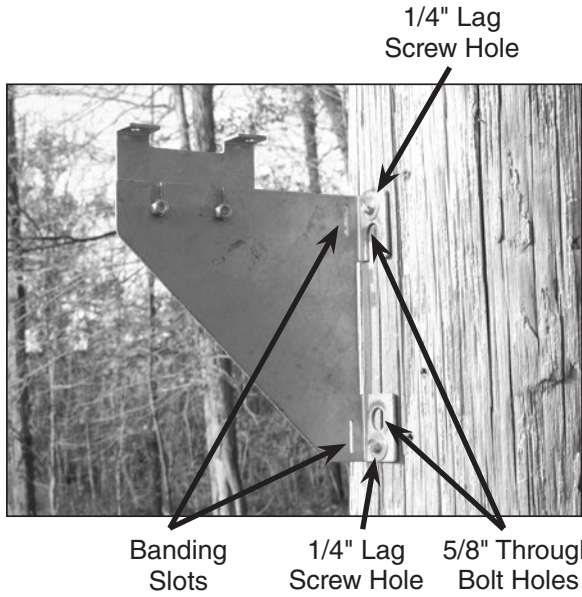

Step #66 The 6.5" COYOTE Dome Pole/Wall Mount Bracket (P/N: 8003702).

Attach the COYOTE Dome closure to the pole/wall mount bracket by inserting the studs of the dome closure end plate through the stud holes of the stud mount plate and securing with the lock nuts provided.

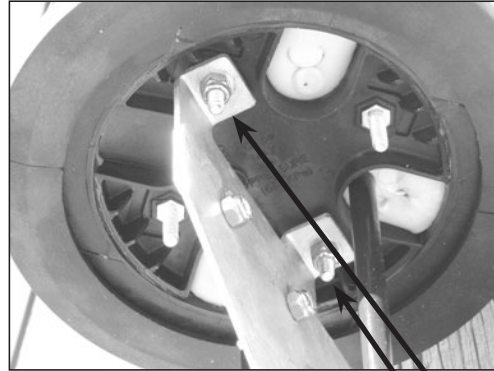

Secure Lock Nuts

SAFETY CONSIDERATIONS

This application procedure is not intended to supersede any company construction or safety standards. This procedure is offered only to illustrate safe application for the individual. **FAILURE TO FOLLOW THESE PROCEDURES MAY RESULT IN PERSONAL INJURY OR DEATH.**

Do not modify this product under any circumstances.

This product is intended for use by trained technicians only. **This product should not be used by anyone who is not familiar with, and not trained to use it.**

When working in the area of energized lines, extra care should be taken to prevent accidental electrical contact.

For proper performance and personal safety, be sure to select the proper size PREFORMED™ product before application.

PREFORMED products are precision devices. To insure proper performance, they should be stored in cartons under cover and handled carefully.



PREFORMED LINE PRODUCTS

P.O. Box 91129, Cleveland, Ohio 44101 • 440.461.5200 • www.preformed.com • e-mail: inquiries@preformed.com

SP2980-8